



Hoop II Multi-Mount Step Installation Instructions

Part No's: 107441-1 / 107442-1 / 107444-1 / 107447-1



DIAGRAM A & B ARE VIEWED FROM THE DRIVERS SIDE

Diagram A

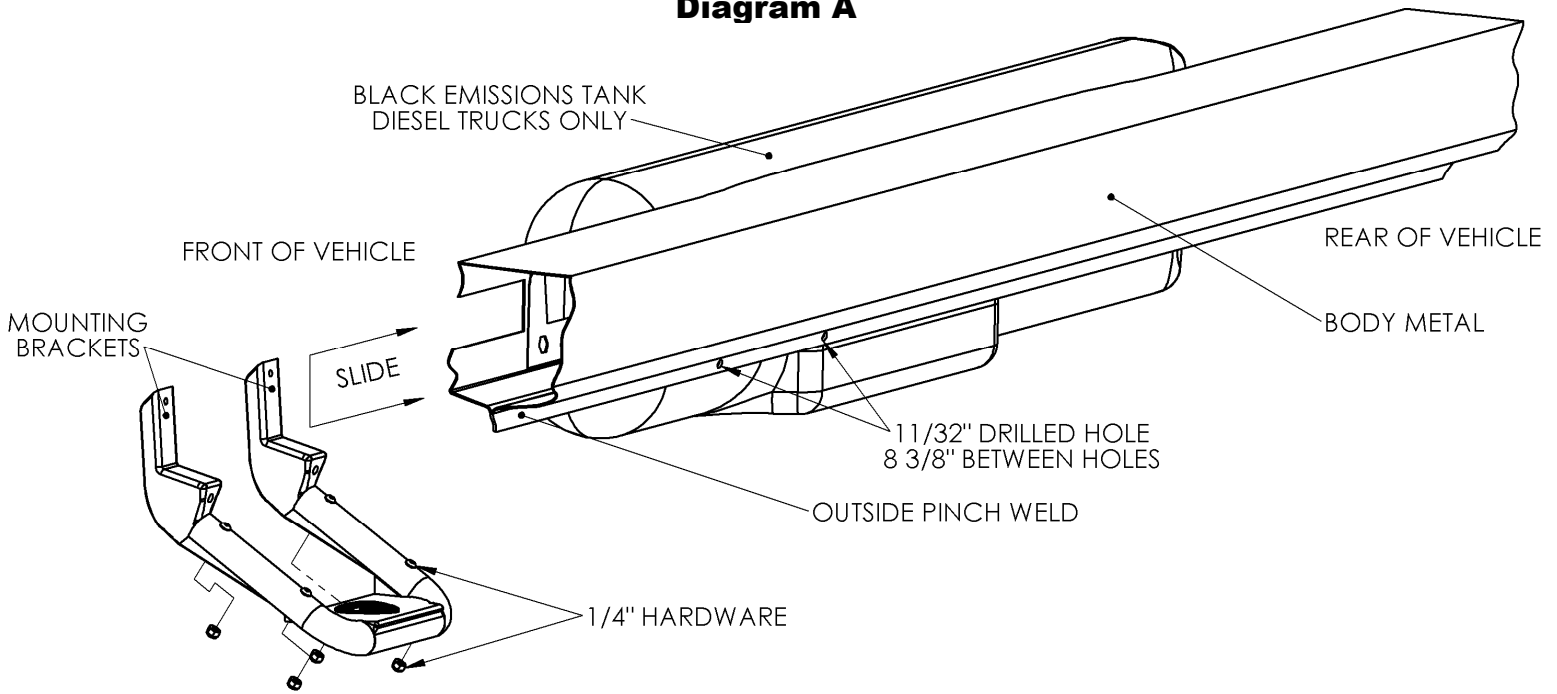
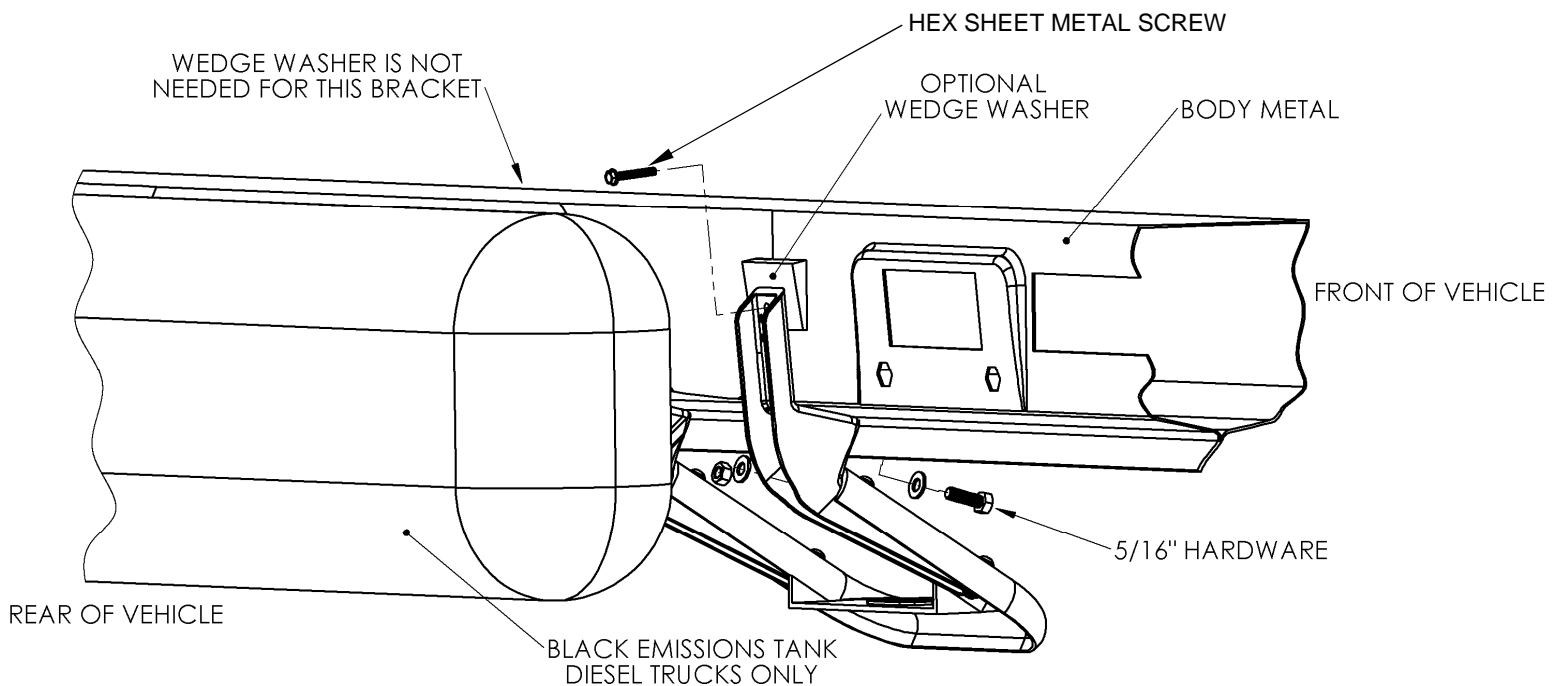

Diagram B





Hoop II Multi-Mount Step Installation Instructions

Part No's: 107441-1 / 107442-1 / 107444-1 / 107447-1



WARNINGS!

- ✓ Do not over tighten the nuts and bolts or damage to the castings and or stripping of the threads could result.
- ✓ FOR SAFE AND PROPER USAGE OF THIS PRODUCT, THE MOUNTING INSTRUCTIONS MUST BE FOLLOWED CAREFULLY AND COMPLETELY.
- ✓ The manufacturer and distributor of this product are in no way responsible for the consumer's failure to adhere to the warnings and directions of these instructions in the event of damage to the consumer's vehicle, other properties and or personal injury.



Quality and Style that Endures

Follow the diagram and the written directions carefully for a proper, safe installation.

Should you encounter an unusual, unforeseen problem, contact our Technical Help Line

7:00 AM – 3:00 PM Pacific Time
(951) 719-1068

Visit our web-site at

www.CARR.com

Warranty Information
on our website

Carr Pattern Co., Inc.

Carr Pattern Co., Inc. Warranty Policy

Finishes: Limited Lifetime

Structural Warranty: Limited Lifetime

Warranty Conditions:

- a. All warranties start from consumer's date of purchase.
- b. A new product will be sent out immediately to replace a warranty claim.
- c. The above guidelines apply only to the Original Purchaser.
- d. Original proof of purchase must be submitted for all warranty and returns issues.

Warranty Limitations:

- a. Warranty coverage extends ONLY to repair or replacement of the CARR product. This warranty does not cover the cost of labor, transportation, installation or removal of the product.
- b. Warranty coverage does not extend to damage caused by: collision, fire, theft, freezing, vandalism, riot, explosion or object striking the product, or misuse of the product and/or the vehicle on which the product is being installed.
- c. Warranty coverage does not extend to damage caused by: airborne fallout (chemicals, tree sap, etc.), stones, hail, earthquake, water or flood, windstorm, lightning, the application of chemicals or sealants subsequent to manufacture.
- d. Warranty coverage does not extend to damages caused by: normal wear and tear, abuse, modification or improper installation of the product.
- e. Warranty coverage does not extend to any economic loss or extra expense including (without limitation), payment for the loss of time or pay, inconvenience, storage, loss of vehicle use, vehicle rental expense, equipment rental expense, lodging, meals, or other travel costs.

Other Terms:

This warranty gives you specific legal rights and you may also have other rights that vary from state to state. CARR does not authorize any person to create for it any other obligation or liability in connection with its products.

ANY IMPLIED WARRANTY OF MERCHANTABILITY OR FITNESS FOR A PARTICULAR PURPOSE APPLICABLE TO THIS PRODUCT IS LIMITED IN DURATION TO THE DURATION OF THIS WRITTEN WARRANTY. PERFORMANCE OF REPAIRS AND NEEDED ADJUSTMENTS IS THE EXCLUSIVE REMEDY UNDER THIS WRITTEN WARRANTY OR ANY IMPLIED WARRANTY. CARR SHALL NOT BE LIABLE FOR INCIDENTAL OR CONSEQUENTIAL DAMAGES RESULTING FROM BREACH OF THIS WRITTEN WARRANTY.*

*Some states do not allow limitations on how long an implied warranty will last or the exclusion or limitation of incidental or consequential damages, so that above limitations or exclusions may not apply to you.

Guarantee: Every attempt has been made to manufacture and distribute the finest quality products available. Our manufactured products are guaranteed to be free of defects due to workmanship or materials. Distributed products are subject to manufacturer's warranty only.

Vehicle Application:

DODGE

'11-'20 Ram 3500-5500 Reg. Cab
(Diesel only) Chassis Beds Only

**WAX YOUR STEP ON A
REGULAR BASIS TO
MAINTAIN ITS LUSTER**

MATERIAL NEEDED:

Drill motor, 11/32" drill bit, 1/8" drill bit, pencil, flat blade screw driver or 5/16" socket, center punch, two 1/2" wrenches, one 7/16" wrench, 5/32" Allen Wrench and silicone.

MATERIAL FURNISHED:

1 step casting, 2 mounting brackets, instruction page and 1 hardware packs
(Not all hardware may be used)

1. These steps mount to an extremely strong part of your vehicle, the back side of its rocker panels. For the proper position of the step, the front edge of the seat while in normal driving position should be in line with the center of the step. For personal preference or to avoid any obstruction that may be on the backside of the rocker panel, the step can be moved towards the front or the rear of the vehicle.
2. Assemble two mounting brackets to a step as shown in Diagram A using the 1/4" hardware provided and with your 5/32" Allen wrench and 7/16" wrench.
3. Take that assembly and slide it in from the front of the vehicle between the Black Emissions Tank and the Body Metal as shown in Diagram A.
4. Position the step assembly in the general location as shown in Diagram B.
5. Using the Mounting Brackets as a guide, take a pencil and mark the center of each Mounting Bracket on the Outside Pinch Weld with a vertical line. See Diagram A.
6. Remove your step assembly.
7. Measure 3/8" up from the bottom of the pinch Weld and mark a horizontal line. This will create a cross-air mark. The distance between the center of each cross-air mark needs to be 8 3/8". If not make the necessary adjustment to correct the dimension.
8. Take your Center Punch and punch the center of each cross-air mark.
9. Take your Drill Motor with a 1/8" drill bit and drill out marked holes.
10. Go back and drill out the 1/8" hole with a 11/32" drill bit. Remove all burrs.
11. Slide the step assembly back into position. With the 5/16" hardware provided, hand tighten the step to the vehicle.
12. If you are using the Wedge Washer, position it now so that it takes up any slack between the front Mounting Bracket and the Vehicle Body Metal. See Diagram B.
13. Take the drill motor again and drill out the hole at the top of the front Mounting Bracket. Drill through the Wedge Washer and Vehicle Body Metal.
14. Take the 1" Hex Sheet Metal screw provided with your 5/16" socket wrench and securely tighten the screw. **NOTE: You will not be able to put a Hex Sheet Metal screw on the back Mounting Bracket due to interference from the Black Emissions Tank.**
15. Go back and securely tighten all the 5/16" hardware.
16. Repeat all of the above for the passenger side of your vehicle.
17. The passenger side will not have the Black Emissions Tank in your way so you will be able to place the Step Assembly into position easier and you will be able to install the Hex Sheet Metal screws for both Mounting Brackets.
18. Use silicone on all drilled areas to insure a better weather resistant installation.
19. Your steps are ready for use.